

SINGER
91K3,K4

ILLUSTRATED
LIST OF PARTS

FOR

Class 91K Machines

(91K3 and 91K4)



THE SINGER MANUFACTURING COMPANY.

25537

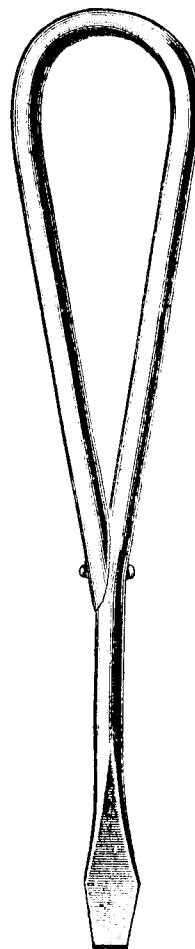

86405



36569

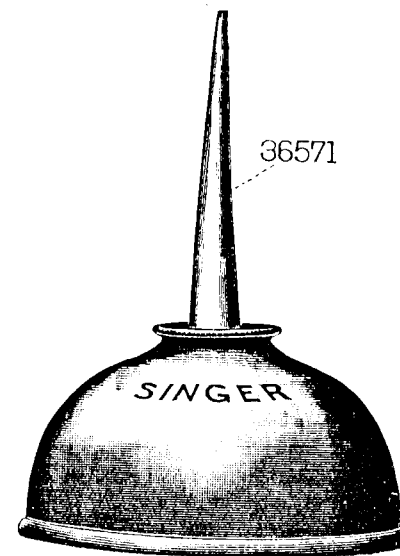

36571

2/25

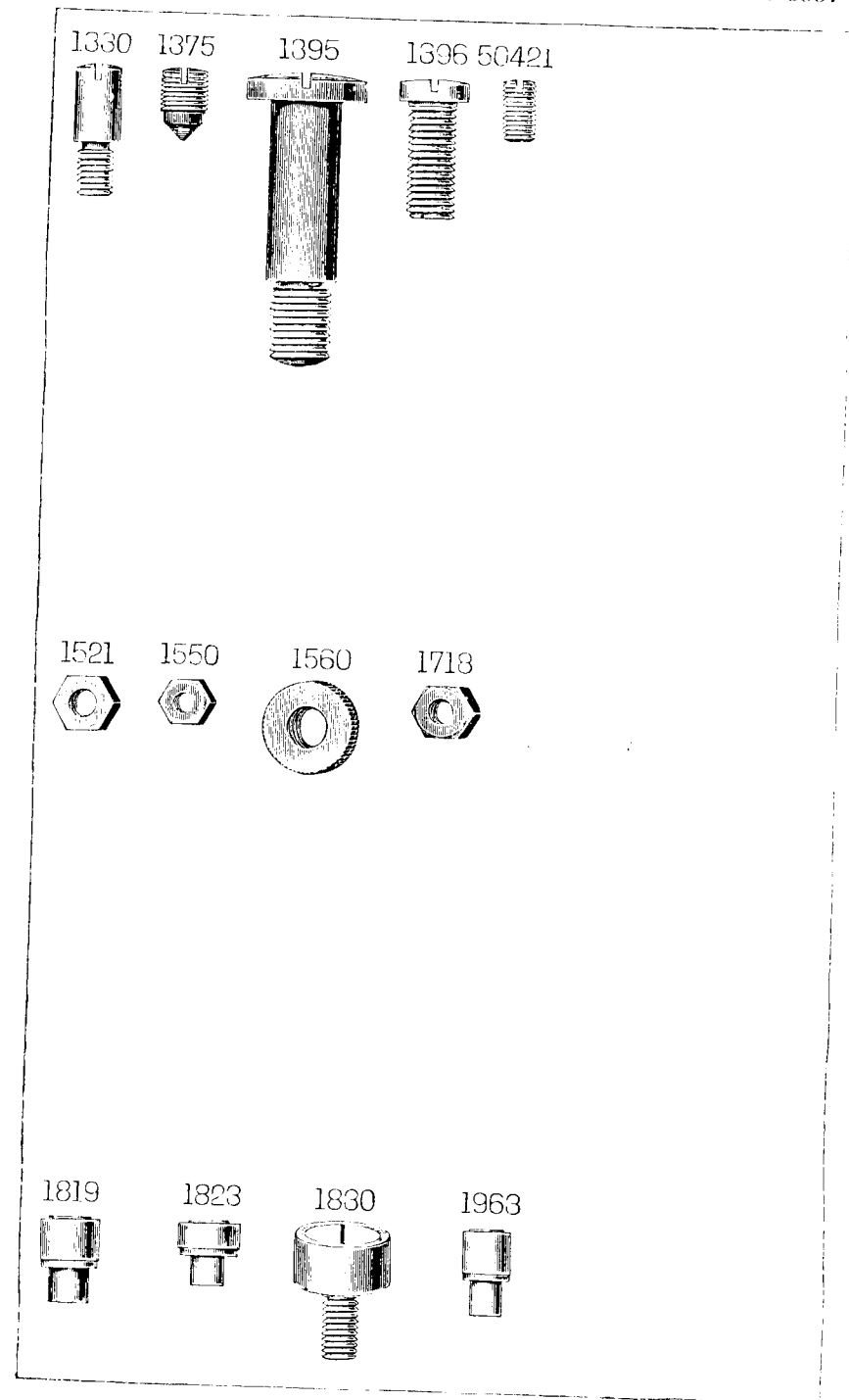
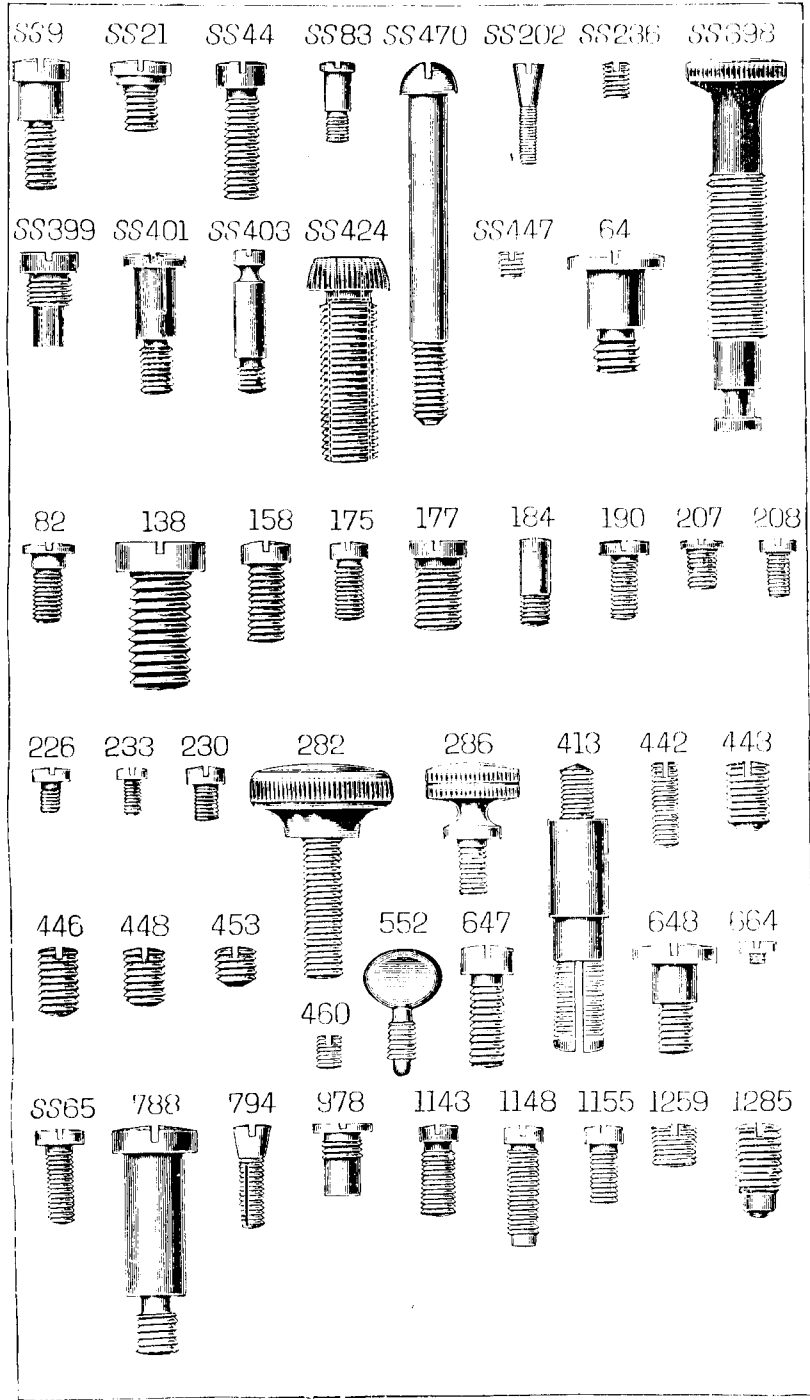

95852 95855 95935

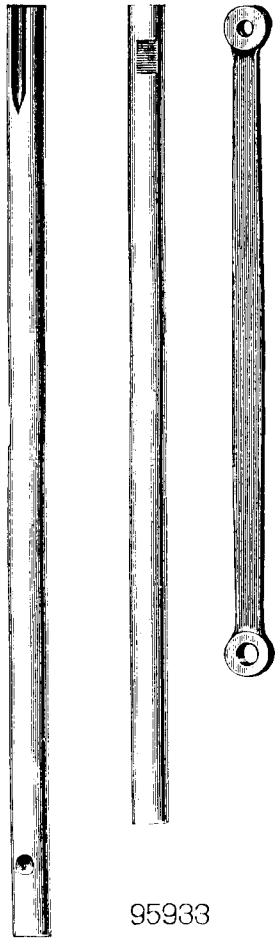

95947

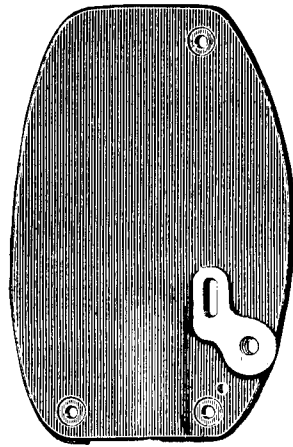

95904

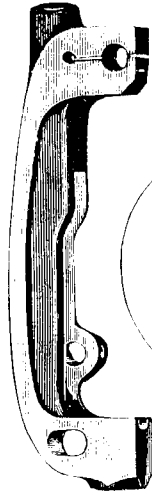

8300

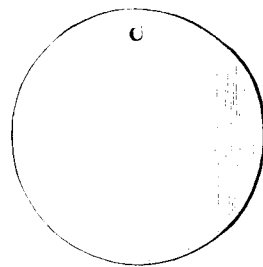

95933

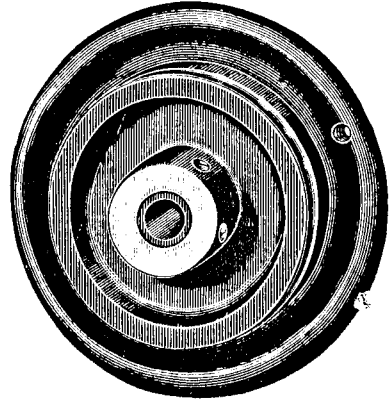

95937

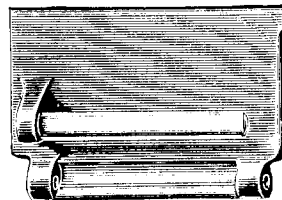

95865

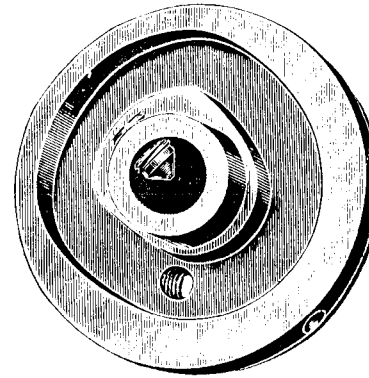

95932

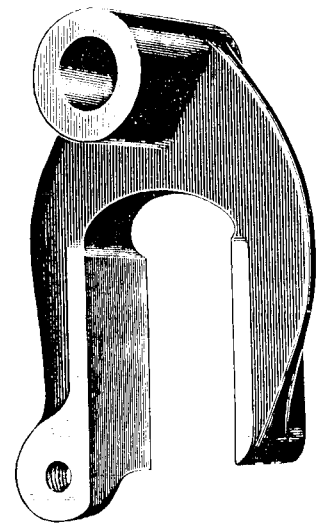

95854

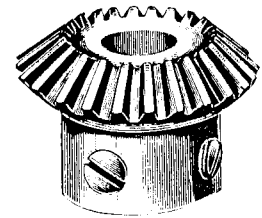

95853

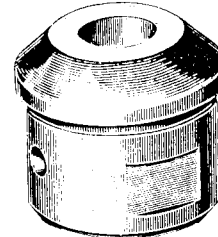

95931

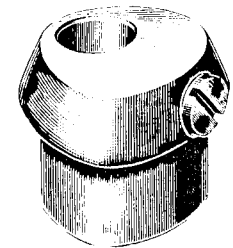

95930

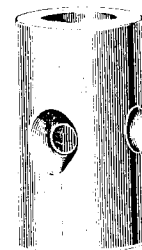

95891

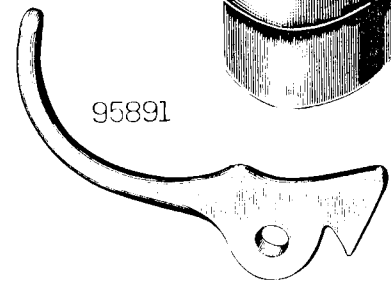

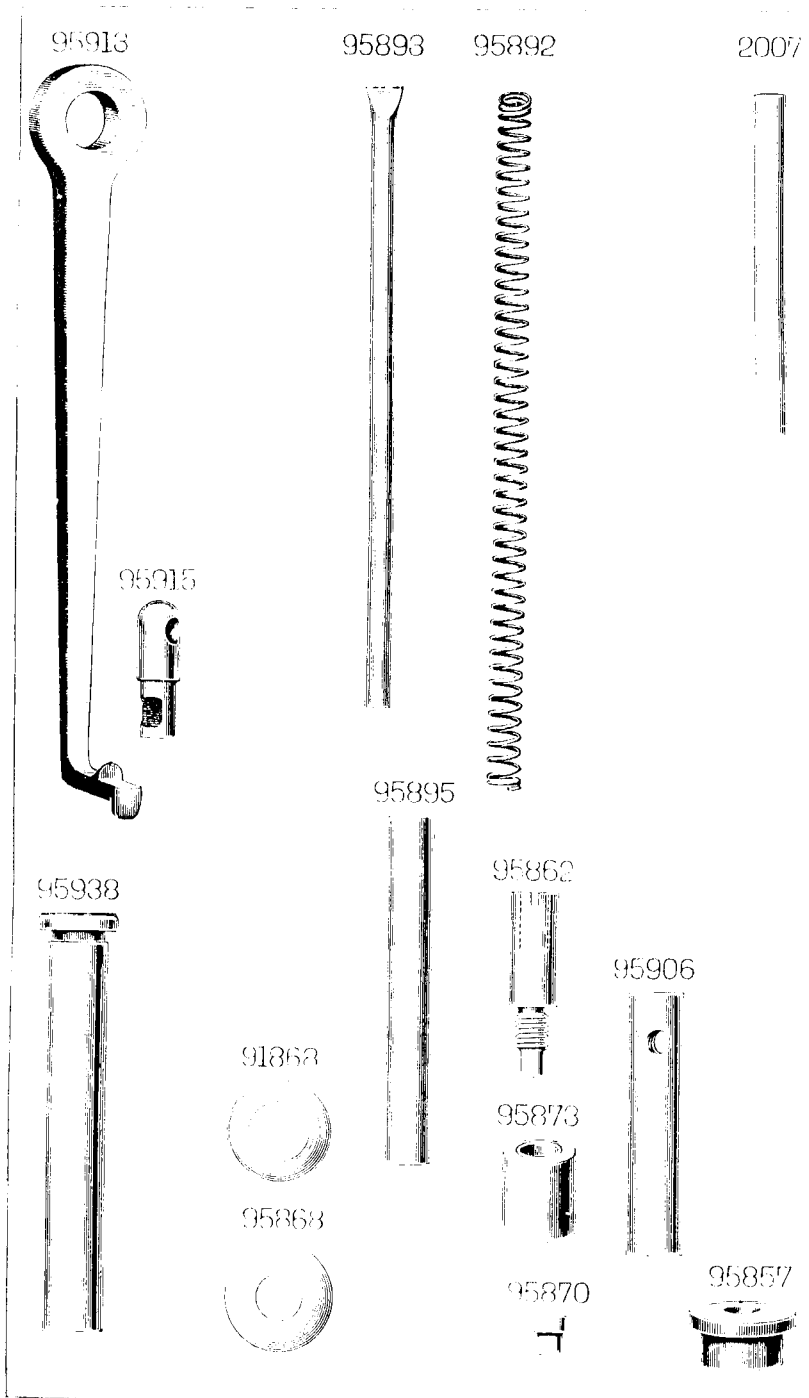
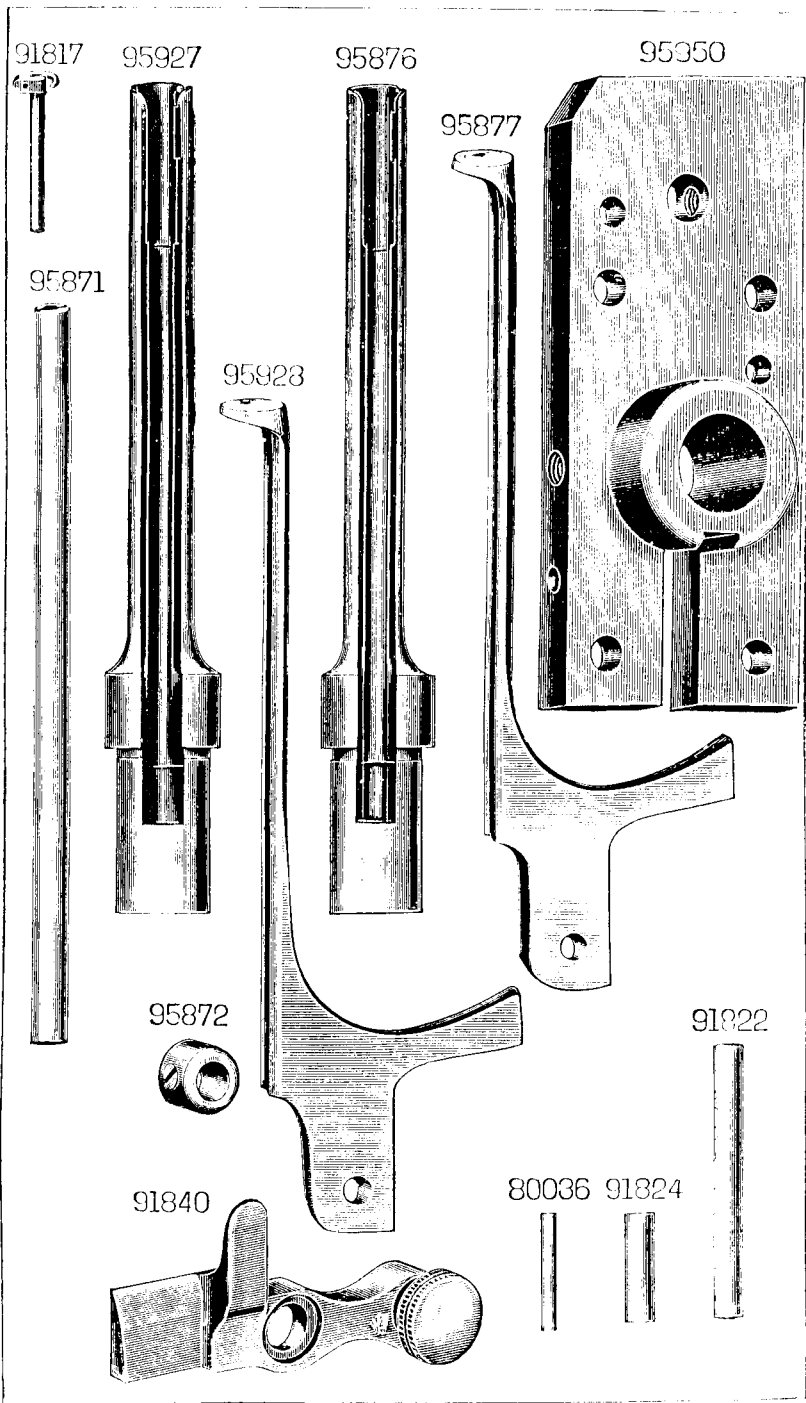

95886

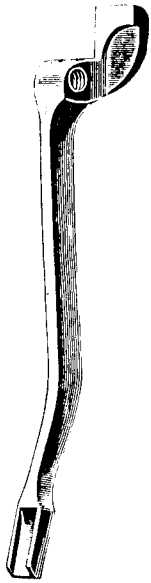

95887



91879

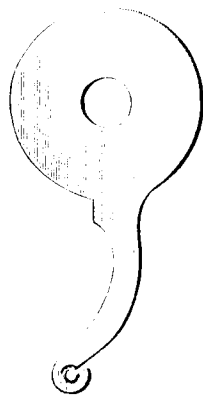

95920

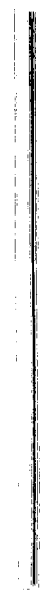

32575



32576

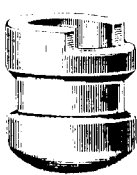

2102

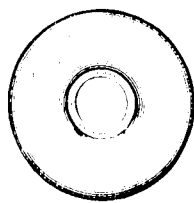

8238



95863

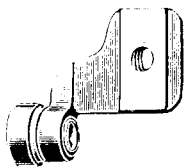

95916

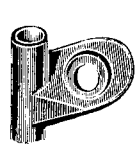

95917

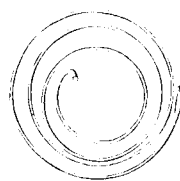

91881



95869



95954

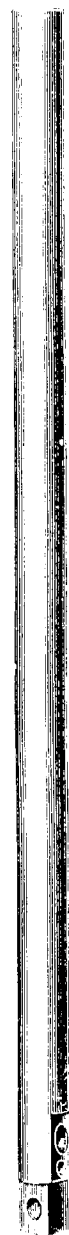

95956



95960

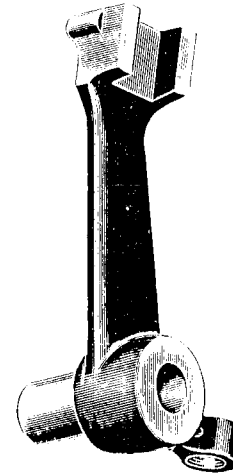

95952

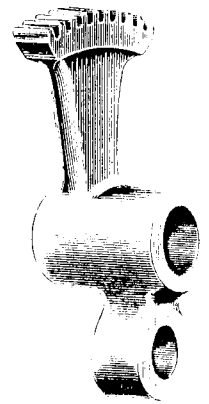

95959

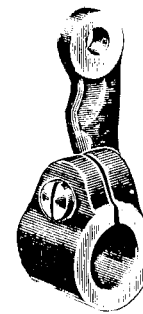

95953



95961

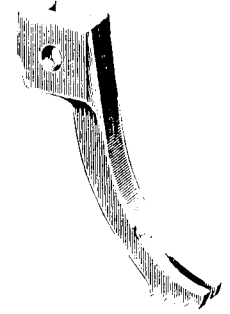

95951



66



95957



440



1700



95955



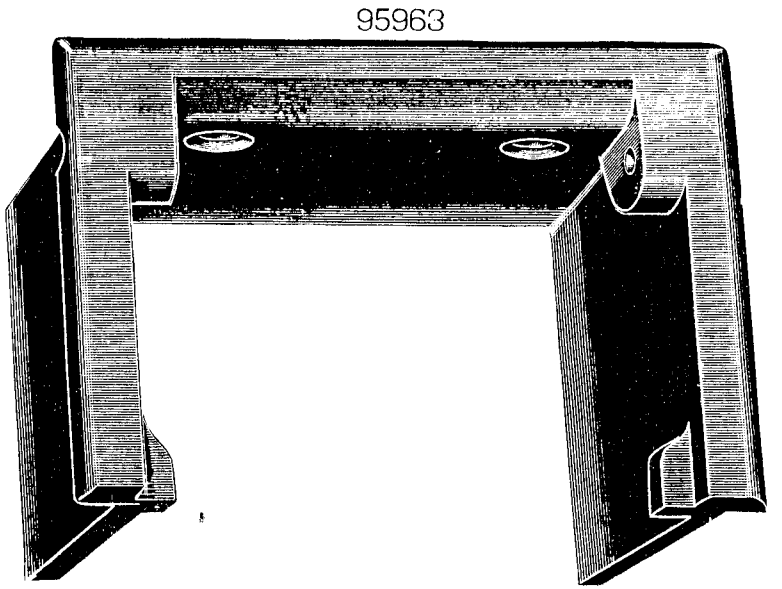
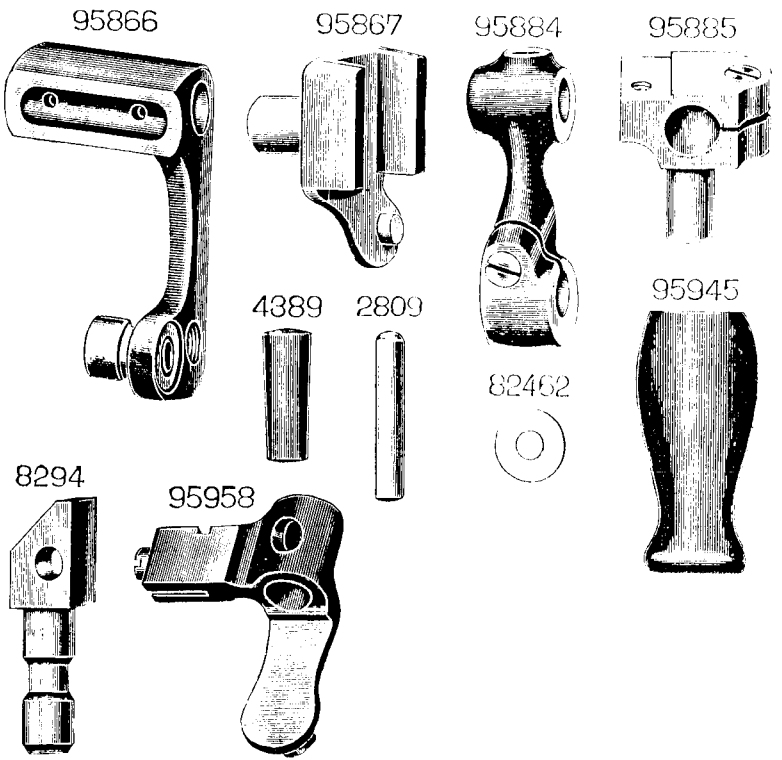

CONTENTS

	Page
Parts, complete, for No. 91K3 Machine	23
Parts Special to No. 91K4 Machine	28
Accessories	29

Illustrated List of Parts

FOR

91K3 and 91K4 Machines



In ordering from this List, the prefix and affix letters, with the part number, **MUST BE** quoted exactly as they are shown in the first column.

A number always indicates the same part, in whatever List it may appear, or for whatever machine.

The prefix *SS* indicates Screws made only at Singer.

" " *NN* " Nuts made only at Singer.

" " *RR* " Rollers and Studs made only at Singer.

The affix Letters (where shown) indicate the style of finish, as follows:—

A. Hardened, Polished and Plated.

B. Polished and Plated.

C. Hardened only.

D. Polished only.

E. Soft, not Polished.

F. Hardened and Polished.

H. Blued.

J. Plated only.

K. Hardened and Plated.

L. Brass or Gilt.

M. Oxidised.

P. Japanned.

R. Parkerised.

In this series:

1 to 1500 and 50001 to 51500 are Screw Numbers.

1501 " 1800 are Nut Numbers.

1801 " 2000 " Roller " "

2001 " 50000 are numbers of machine parts, etc.

80001 " 100000 are numbers of machine parts, etc.,
made only at Singer.

Parts marked with an asterisk () are furnished only when the repairs are made at Factory.*

PARTS COMPLETE

FOR

No. 91K3 MACHINE

Has Direct Gear Driven Looper Mechanism and Adjustable Top Feed; makes a Double Chain Stitch (Piqué); diam. of Post $\frac{11}{16}$ "; for Glove Work.

No.	Plate							
*95851		Arm
4389	143	" Dowel Pin (2)
95858		" Oil Tube
138c	1356	" Screw (3)
95852	1437	Arm Shaft (horizontal)
95853	1438	" " (") Bush (front)
143c	1356	" " (") " (") Set Screw
95930	1438	" " (") " (rear)
148c	1356	" " (") " (") Set Screw
95854	1438	" " (") Gear with two 1259c
1259c	1356	" " (") " Set Screw
95855	1437	" " (upright)
95931	1438	" " (") Cam with 177c
95932	1438	" " (") " Fork
1395f	1357	" " (") " Hinge Screw
177c	1356	" " (") " Set Screw
95854	1438	" " (") Gear with two 1259c
1259c	1356	" " (") " Set Screw
8300	1437	Arm Side Cover
286d	1356	" " " Thumb Screw
2007	1440	" Spool Pin
95857	1440	" " " Bushing
95859		Balance Wheel (2" diam.) with 446c and 1285c
95933	1437	" " (2 1/2" ") " 446c " 1285c
95934		" " (2 1/2" ") " 446c " 1285c
<i>NOTE: Balance Wheel No. 95933 is supplied with this Machine unless otherwise specified on order.</i>								
95945	1413	Balance Wheel Handle (Wood)
SS470d	1356	" " " Screw Spindle
1285c	1356	" " Position Screw
446c	1356	" " Set Screw
*95946		Bed

No.	Plate							
95917	1437	Face Plate
190d	1356	" " Screw (B)
95862	1440	" " Stud
95863	1441	" " Thread Nipper Bracket with 1823
SS65b	1356	" " " " " Screw
82462	1443	" " " " " Washer
1823	1357	" " " " " Roller
95865	1438	Feed Cam with 1375c
1375c	1357	" " Set Screw
95866	1443	Feed Lever with 1819
1819	1357	" " Roller
95948		Feed Lifting Mechanism, complete, Nos. 140c, 1524c, 1700c, 1830, 95895, 95959 and 95960
95867	1443	Feed Regulator with 95870
95869	1441	" " Slide Block
978c	1356	" " " " Hinge Screw
95868	1440	" " Spring Washer
647d	1356	" " " " Screw
95870	1440	" " Stud
SS398c	1356	" Regulating Thumb Screw
184c	1356	" " Stop Screw
91817	1439	Looper
95943		" 91817 with 95871
95927	1439	Looper Column with 80036
95928	1439	" " Hinged Needle Plate
91822	1439	" " " " Hinge Pin
80036	1439	" " Thread Guide Pin
95949		Looper Column, complete, Nos. 1448c, 91822, 95872, 95873, 95927, 95928, 95943, 95950 and 95951
95950	1439	Looper Frame
SS44c	1356	" " Binding Screw (long) (2)
158c	1356	" " " " (short) (2)
91824	1439	" " Pin (2)
95935	1437	Looper Pitman
648c	1356	" " Hinge Screw (for 95932)
66c	1442	" " " " (or 95952)

No.	Plate							
95871	1139	Looper Spindle
95873	1440	" " Bush
1148c	1356	" " " Set Screw
95872	1439	" " Collar with SS447c
SS447c	1356	" " " Set Screw
95951	1442	" " Pinion with two 233c
95952	1442	" " " Segment Gear
95953	1442	" " " " Stud
1148c	1356	" " " " " Set Screw
233c	1356	" " " Set Screw
95919		Looper Thread Spool Holder Plate
95920	1441	" " " " Hinge Pin
*95936		" " " Pin
95937	1437	Looper Thread Spool Holder, complete, Nos. 95919 and 95936
95963	1443	Looper Thread Spool Holder Frame, for machine without Base
95961		Looper Thread Spool Holder and Frame, complete, Nos. 95920, 95937, 95963 and two Wood Screws 1/2" No. 7
		<i>NOTE No. 95961 is supplied when machine is ordered less Base No. 95921, and is charged extra.</i>						
95918		Machine Base
8294	1443	" " Hinge Connection
2809	1443	" " " " Hinge Pin
453c	1356	" " " " Set Screw
282d	1356	" " Thumb Screw
95921		Machine Base, complete, Nos. 282d, 95918, 95937, two each 453c, 2809 and 8294
95954	1442	Needle Bar
95884	1443	" " Connecting Link with 794c
794c	1356	" " " " Adjusting Screw
1330c	1357	" " " " Hinge Screw
95885	1443	" " " Stud with 175c
175c	1356	" " " " Clamping Screw
95886	1441	" " Thread Nipper
SS83c	1356	" " " " Hinge Screw
95887	1444	" " " " Spring
208f	1356	" " " " Binding Screw
95955	1442	Needle Clamp with 552c
552c	1356	" " Thumb Screw
91840	1439	Needle Plate Latch with 286d
SS96d	1356	" " " Hinge Screw
286d	1356	" " " Thumb Screw

No.	Plate								
95956	1442	Presser Bar
95957	1442	" "	Bushing
95958	1443	" "	Guide Bracket with SS202c
SS202c	1356	" "	" "	Adjusting Screw
1155c	1356	" "	" "	Set Screw
95891	1138	Presser Bar Lifter
184c	1356	" "	" "	Hinge Screw
95959	1442	" "	" "	Lifting Cam Lever with 175c
440c	1442	" "	" "	Adjusting Screw
1700c	1442	" "	" "	" "	Lock Nut
175c	1356	" "	" "	Binding Screw
1830	1357	" "	" "	Roller and Stud
1521c	1357	" "	" "	" "	Lock Nut
95960	1442	" "	" "	Lever
95895	1440	" "	" "	Hinge Pin
SS236c	1356	" "	" "	" "	Set Screw (2)
95896	-	" "	" "	Slide Block
95904	1437	Presser Bar Pendulum Bracket
95906	1440	" "	" "	Feed Lever Stud
1155c	1356	" "	" "	" "	Set Screw
95938	1440	" "	" "	Hinge Stud
1396c	1357	" "	" "	" "	Clamping Screw
95892	1440	Presser Bar Spring
95893	1440	" "	" "	Guide Wire
SS424d	1356	" "	" "	Regulating Thumb Screw
95961	1442	Presser Foot (serrated teeth)
190f	1356	" "	" "	Screw
95913	1440	Seam Guide
64d	1356	" "	" "	Hinge Screw
91868	1440	" "	" "	Spring Washer
184d	1356	" "	" "	Stop Screw
<i>NOTE: -Seam Guide No. 95913 is only supplied with this machine when specified on order and at an extra charge.</i>									
2102	1441	Tension Disc
413c	1356	" "	" "	Screw Stud
8238	1441	" "	" "	Spring
1560d	1357	" "	" "	Regulating Thumb Nut
95914		Tension , complete, Nos. 413c, 1560d, 8238 and two 2102
95915	1440	Tension Thread Guide
SS236c	1356	" "	" "	Set Screw

No.	Plate								
95916	1441	Thread Guide Bracket
207d	1356	" "	" "	Screw
91879	1441	Thread Take-down
SS21d	1356	" "	" "	Hinge Screw
95917	1441	" "	" "	Spring
91881	1441	" "	" "	Stop Pin
175d	1356	" "	" "	" "	Screw
32575	1441	Thread Take-up Spring
32576	1441	" "	" "	Regulator
153c	1356	" "	" "	" "	Set Screw

Accessories

No.	Plate						
-		Instruction Book
16-1		Needles (two each sizes 7, 8 and 9)
36569	1355	Oiler
25537	1355	Screw Driver
86105	1355	Tweezers
		Wood Screws 1 1/2" - 1" (21)

PARTS SPECIAL

TO

No. 91K4 MACHINE

Has Direct Gear Driven Looper Mechanism and Adjustable Top Feed ;
 makes a Double Chain Stitch (Piqué) ; diameter of Post $\frac{5}{16}$ " ;
 for Children's Gloves.

This Machine is the same as No. 91K3 with the following exceptions :

No.	Plate						
95876	1439	Looper Column with 80036
95877	1439	" " Hinged Needle Plate
95962		Looper Column, complete, Nos. 1148, 91822, 95872, 95873, 95876, 95877, 95943, 95950 and 95951